



One common institutional space still
missing a common language

Hearing of the Committee on Civil Liberties, Justice and Home Affairs
13 April 2011, European Parliament

Right to access to EU Documents: implementation and future of Regulation
(EC)N0 1049/20011

Yves Steinitz / Publications Office of the European Union

Objectives

Give the citizen transparent and easy access to Law

**Making all legislation and other official texts available to the public;
developing, maintaining and updating electronic publishing services for the public;
preserving all publications of the institutions and making them available to the
public in electronic form**

Decision 2009/496/EC, Euratom of 26 June 2009 on the organisation and operation of the Publications Office of the European Union (OJ L 168 of 30.06.2010)

**Guarantee right of access to documents of the Union's institutions, bodies, offices
and agencies**

Treaty on the Functioning of the European Union, Article 15 (OJ C 83 of 30.3.2010)

Improving the transparency of the decision making process

Regulation (EC) No 1049/2001 of the European Parliament and the Council of 30 May 2001 regarding public access to European Parliament, Council and Commission documents (OJ L 145 of 31.5.2001)



The way forward

- The front end : what shall we offer to the user?
 - A common access
 - A unique juridical portal

- What the user should not see:
 - The machinery behind the scenes
 - The conceptual work towards:
 - Modelling
 - Standardisation
 - The practical work : indexation

- The practical applications
 - Knowledge management
 - Semantic web
 - Reuse of public data

- Back to front
 - Transparent and easy access to Law



Home page PO Common Portal (prototype)

This site is a part of  Europa

My Portal ▼ | About Publications Office | FAQ | Help | Contact

English (en) ▼

EU law and publications

EUROPA > EU law and publications

Portal | EUR-Lex | EU Bookshop | Ted | CORDIS | Whoiswho | More ▼

Quick search

Advanced search

Search domains:

- all domains ([EUR-Lex](#), [EU Bookshop](#), [Ted](#))
- EU law (EUR-Lex)
- EU publications (EU Bookshop)
- EU business opportunities (Ted)

Browse

- > EUR-Lex
- > EU Bookshop
- > Ted
- > CORDIS
- > Who is who
- > More ...

Tools and manuals

- > Interinstitutional style guide
- > Thesaurus
- > ...

Practical information

- > FAQ
- > Help
- > Contact
- > How to search

Legal information

- > Legal notice
- > Disclaimer
- > Copyright notice
- > Personal data protection



Search results OP Portal - prototype

This site is a part of  My Portal  | About Publications Office | FAQ | Help | Contact English (en) 

EU law and publications

EUROPA > Publications Office Portal

Portal | EUR-Lex | EUBookShop | Ted | CORDIS | Whoiswho | More 

Refine query

- By domains
 - EU law (22,000)
 - EU publications (1,286)
 - EU tenders (1,968)
- By subject
 - Wind energy (12)
 - Energy policy (9)
 - Sea (3)
 - ...
- By document type
 - Treaties (11)
 - Legislation (8)
 - Preparatory acts (3)
 - ...
- By author
 - European Parliament (8)
 - Council (8)
 - European Commission (7)
 - ...

Search:

About 408 000 000 results (0.22 seconds)

Did you mean? **this word** or **that word**

Sort by:  [Save query](#) | [Create RSS feed](#) | [Alert me](#)

Results 1 –10 of 28 1 2 3 >>

- Lorem ipsum — All the facts — Lorem ipsum generator**
European Commission — Social policy, Social problems — 8 hours ago
Reference site about Lorem Ipsum, giving information on its origins, as well as a random Lorem ipsum generator.
> [TIFF](#) > [xml](#)
- Lorem ipsum dolor sit amet — Lorem Ipsum — All the facts — Ipsum ...**
European Commission — Social policy, Social problems — 1 day ago
Lorem ipsum dolor sit amet, consectetur adipiscing elit. Nulla faucibus ...
> [html](#) > [PDF](#) > [doc](#)
- Lorem ipsum – Wikipedia, the free encyclopedia**
European Commission — Social policy, Social problems — 2 days ago
In publishing and graphic design, lorem ipsum is placeholder text (filler text) commonly used to demonstrate the graphic elements of a document or visual ...
> [PDF](#)
- Lorem ipsum dolor sit amet - loremipsum.net**
European Commission — Social policy, Social problems — Mar 26, 2011
Lorem ipsum dolor sit amet, consectetur adipiscing elit, sed diam nonummy nibh euismod tincidunt ut laoreet dolore magna aliquam erat volutpat.
> [html](#) > [PDF](#) > [TIFF](#)



Home page « New EUR-Lex »

About EUR-Lex | Site map | Glossary | FAQ | Help | Contact | Useful links | Legal notice

Portal **EUR-Lex** EU BookShop Ted **CORDIS** Whoiswho More ▾ English (en) ▾

EUROPA > Access to law and publications > EUR-Lex



Access to European Union law

Quick search in EUR-Lex ▾ 🔍

[Advanced search](#) [Expert search](#)

[Official Journal](#) | [EU Law](#) | [National Law](#) | [Legislative procedure](#) | [More](#)

28 OJ of the day :
[L323](#) [L324](#) - [C300](#)

 **EU enlargement**

[About EU Law](#) ▾

[Practitioner's corner](#) ▾

Introduction

Mauris porttitor vehicula nisi a sagittis. Aliquam ut orci et libero fermentum volutpat in sit amet nisi. Pellentesque porttitor consectetur arcu, eget elementum velit tincidunt in. Cras ullamcorper vestibulum odio, eget laoreet nulla molestie sit amet. Aliquam erat volutpat

News

News Thematic files From the editor

- Newsletter 09/07/2010
- Newsletter 09/11/2009
- Newsletter 05/11/2008
- Newsletter 20/10/2008
- Newsletter 22/09/2008

More...

Recently published

Official Journal **Case-Law** COM SEC Consolidated documents

- 2010/09/07 : C-270/09 - Macdonald Resorts Limited
- 2010/09/02 : C-52/09 - TeliaSonera
- 2010/09/02 : C-254/09 - Klein Trademark Trust v OHIM
- 2010/09/02 : C-453/08 - Karanikolas and Others
- 2010/07/29 : C-54/09 - Greece v Commission

More...

Login / Register





My EUR-Lex

- 0 Query(ies)
- 0 Document(s)
- 0 Personalised RSS feed(s)



EUR-Lex RSS feeds

EUR-Lex Social network

SHARE    

Welcome to EUR-Lex

- [About EUR-Lex](#)
- [Guided Tour](#)
- [FAQ](#)
- [Help](#)
- [Statistics about visits and visitors](#)
- [Webservice registration](#)



Visualisation of a legislative procedure

Procédure 2007/0807/CNS

JAI (2007) 4 - : Initiative de la République fédérale d'Allemagne et de la République française en vue de l'adoption par le Conseil de la décision-cadre 2007/.../JAI du ... concernant la reconnaissance et la surveillance des peines assorties du sursis avec mise à l'épreuve, des peines de substitution et des condamnations sous condition INITIATIVE de la République fédérale d'Allemagne et de la République française en vue de l'adoption par le Conseil d'une décision-cadre concernant la reconnaissance et la surveillance des peines assorties du sursis avec mise à l'épreuve, des peines de substitution et des condamnations sous condition

Act adopté: 32008F0947



● : Conseil ● : Parlement européen ● : Commission

Evénements

- Adoption formelle par Conseil
27/11/2008
- Discussions au Conseil
06/12/2007
- Discussions au Conseil
08/11/2007
- Avis du Parlement européen en lecture unique
25/10/2007
- Discussions au Conseil
12/06/2007

Base(s) juridique(s):

Etat Membre : Traité/UE/art 31 par 1, art 4 par 2

Procédure:

Etat Membre : Procédure de consultation
Conseil: Procédure de consultation

Type de dossier:

Etat Membre : Projet de décision-cadre du Conseil
Conseil: Décision-cadre du Conseil



Stock/
Archive

Dissemination

Production

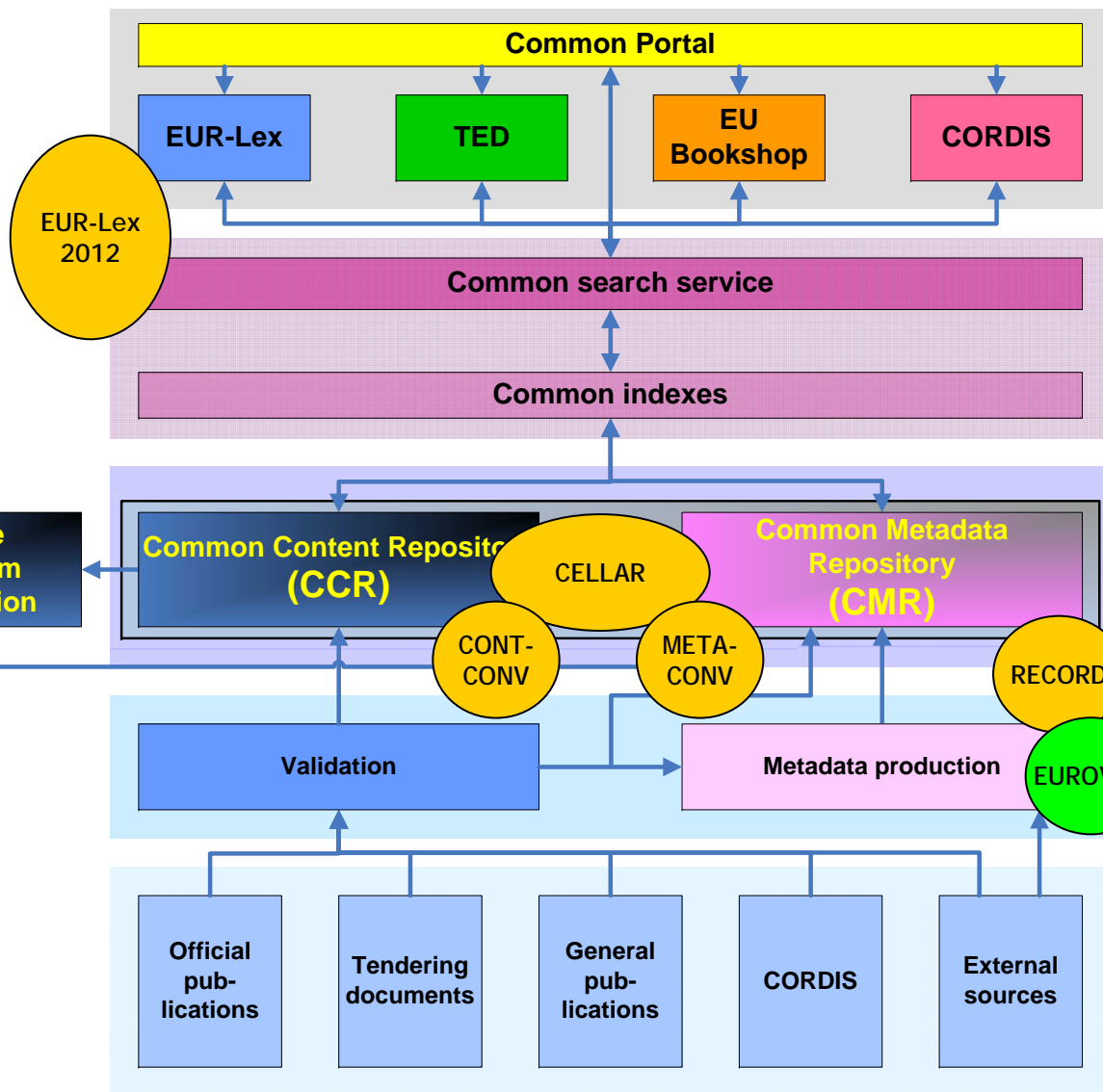

Portal

Index and
Search

Content
and
Metadata

Post-production

Production



Legislative procedures - minimum set of metadata

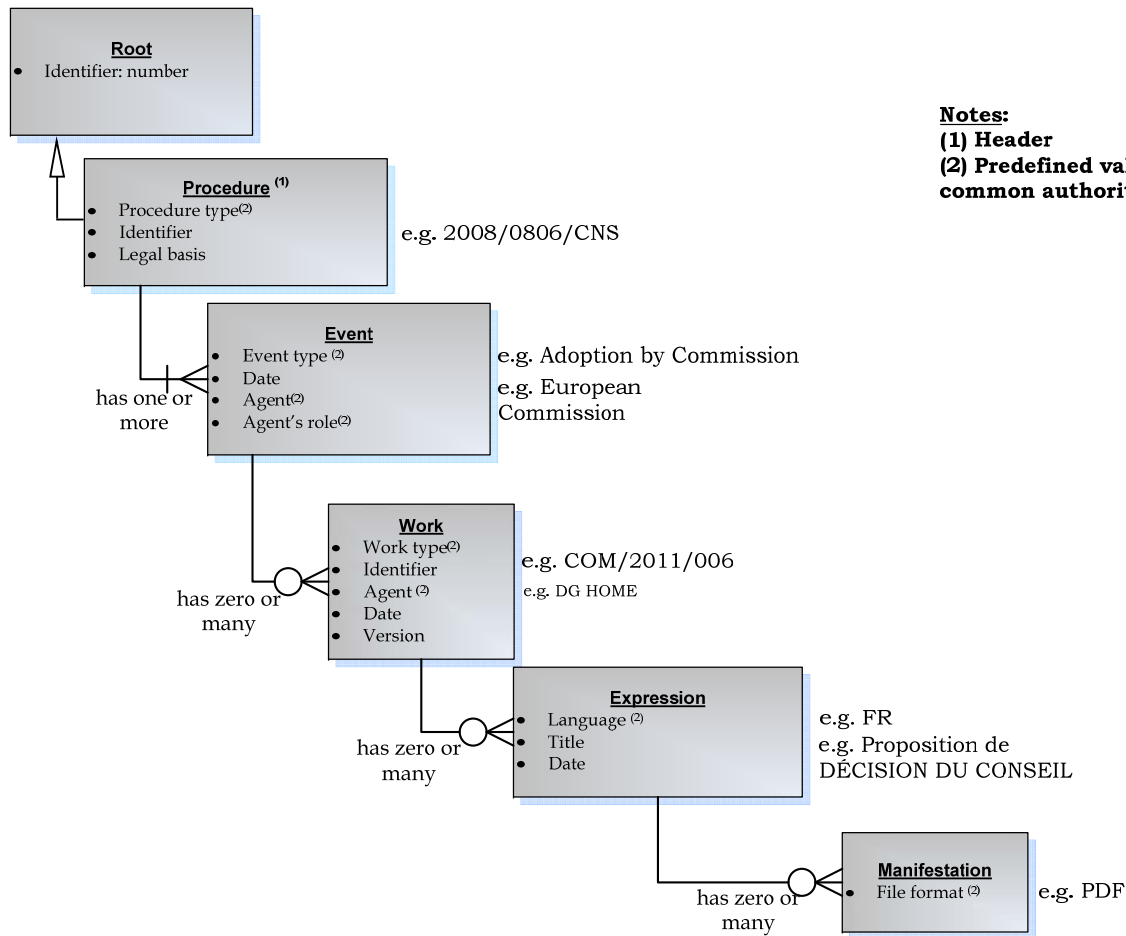

Notes:

(1) Header

(2) Predefined values based on common authority tables



Common Data Model for documents

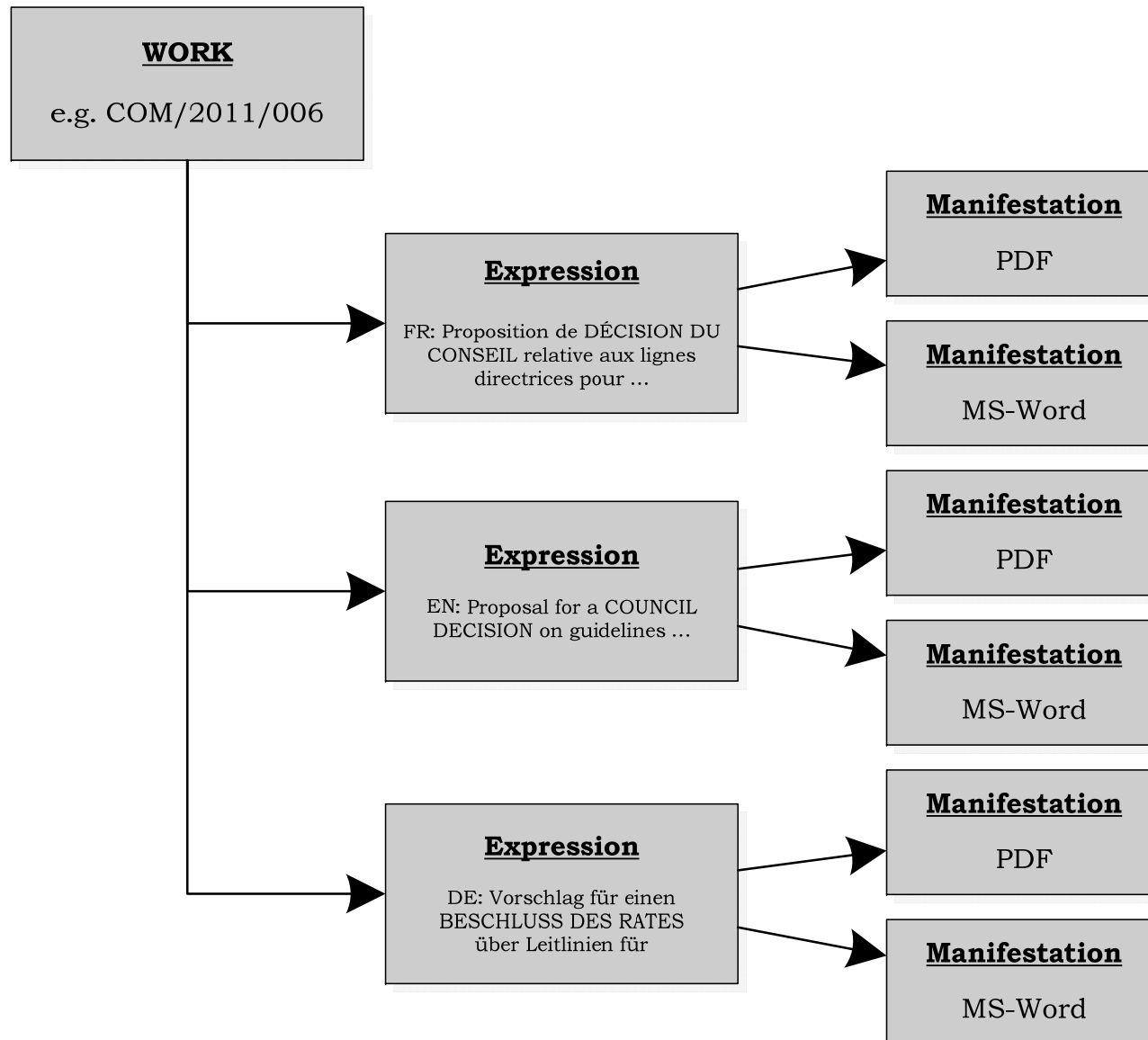

Metadata normalization

■ Example for the European Parliament

Start.use	Date of entry into force	End.use	Label	Code *
1951-04-18	1952-07-24	1957-12-31	Common Assembly	EP
1957-03-25	1958-01-01	1962-03-29	European Parliamentary Assembly	EP
1962-03-30	1962-03-30		European Parliament	EP

One single code instead of « ASSCOM » | « ASSPARL » | « PE » | « PARL »



Common Authority Tables (CAT)1

Common Authority Tables	Source
Languages (ISO 639/1, 639/2B T, 639/3)	ISO
Countries (ISO 3166/1-α2 and α3, 3166/3)	ISO
NTU (incl. NUTS and ISO 3166-2)	ISO + UNO + Eurostat
Currencies (ISO 4217)	ISO
Corporate Bodies	Various sources
Roles	LC + EUR-Lex + PreLex
Places (locations, towns)	UN-LOCODE
Resource format (incl. dimensions)	ONIX + IANA
Resource type (categories of resources)	Internal sources
Target Audience	ONIX
Procedure type	Institutions
Event type	Institutions
Etc.	

in progress

stable version

to be started



Interinstitutional Metadata Maintenance Committee

- Who: The Interinstitutional Metadata Maintenance Committee (IMMC) consists of representatives of the following EU bodies: European Parliament, Council of the EU, European Commission, Court of Justice of the EU, European Court of Auditors, European Economic and Social Committee, Committee of the Regions
- Role: define the minimum set of metadata elements and authority data that are relevant for the exchange of data between the institutions involved in the decision making process and the Publications Office
- When: kick-off meeting on 25 February 2011; next meeting in May 2011



Metadata governance on interinstitutional level

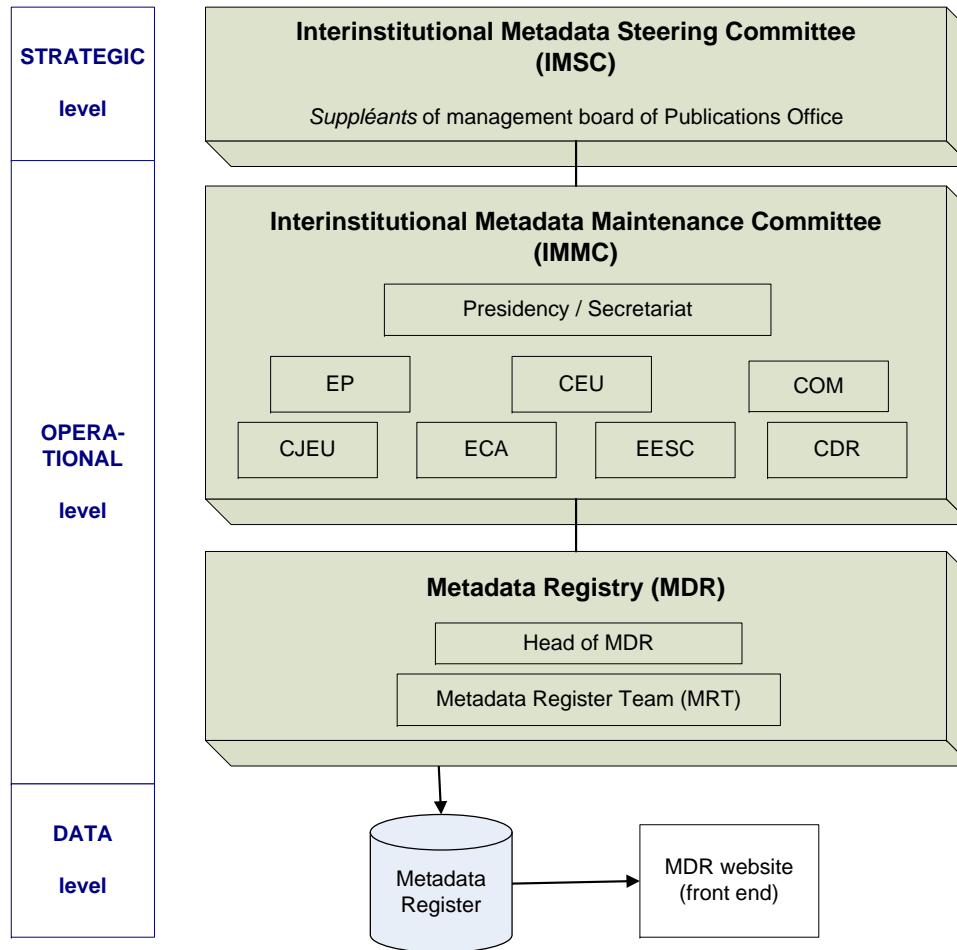

Visualisation of a notice of a legislative act

Bibliographie Texte Documents liés Tout

Masquer tout | Etendre tout

Titre et référence

Règlement (CE) n° 358/2005 de la Commission du 2 mars 2005 concernant l'autorisation sans limitation dans le temps de certains additifs et l'autorisation de nouveaux usages d'additifs déjà autorisés dans l'alimentation des animaux Texte présentant de l'intérêt pour l'EEE

JO L 57 du 3.3.2005, p. 3-12 (ES, CS, DA, DE, ET, EL, EN, FR, IT, LV, LT, HU, NL, PL, PT, SK, SL, FI, SV)

JO L 275M du 6.10.2006, p. 192-201 (MT)

édition spéciale bulgare: chapitre 03 tome 62 p. 256 - 264

édition spéciale roumaine: chapitre 03 tome 62 p. 256 - 264

Langue originale

- Versions linguistiques : les langues officielles, autre langue que communautaire, islandais, norvégien

Dates

- Date du document : 02/03/2005
- Date d'effet : 06/03/2005; entrée en vigueur date de publication + 3 voir art. 5
- Date de fin de validité : 99/99/9999

Classifications

- Descripteur Eurovoc :
 - additif alimentaire
 - alimentation animale
 - autorisation de vente
- Répertoire de la législation en vigueur :
 - 03.50.10.00 Agriculture / Harmonisation des législations et police sanitaire / Aliments pour animaux
- Matière : aliments des animaux

Informations diverses

- Auteur : Commission européenne
- Type d'acte : règlement
- Information supplémentaire : intérêt pour l'EEE, extension à l'EEE par 22005D0108

Procédure

- Histoire législative : avis Comité permanent

Élargissement de l'UE

Mon EUR-Lex



- Requêtes(s)
- Document(s)
- Flux RSS personnalisé(s)





Login

- Connection avec ECAS
- Vous n'avez pas encore de compte ECAS ? [Veuillez vous enregistrer.](#)

Flux RSS EUR-Lex

EUR-Lex Réseau social

SHARE   

EUR-Lex  Parcourir  Informations pratiques  Informations légales 



EuroVoc

- Controlled vocabulary available in 22 EU languages
- 2 other languages (Croatian and Serbian)
- The meaning of each concept is non ambiguous
 - Semantic network and relationships
 - Term and language equivalence

nuclear weapon

UF *atom bomb*
atomic bomb
atomic weapon
hydrogen bomb
neutron bomb
nuclear bomb
nuclear device

08 INTERNATIONAL RELATIONS

MT 0821 defence

BT1 weapon of mass destruction
BT2 military equipment

NT1 strategic nuclear weapon
NT1 tactical nuclear weapon

RT nuclear technology [6621]
nuclear test [6621]
nuclear war [0816]

CONTRIBUTE

MAP

LANGUAGE EQUIVALENTS

BG	ядрено оръжие
ES	arma nuclear
CS	jaderná zbraň
DA	atomvåben
DE	Kernwaffe
ET	tuumarelv
EL	πυρηνικά όπλα
EN	nuclear weapon
FR	arme nucléaire
IT	arma nucleare
LV	kodolierocis
LT	branduolinis ginklas
HU	nukleáris fegyver
MT	nuclear weapon (<i>under translation</i>)
NL	kernwapen
PL	broń jądrowa
PT	arma nuclear
RO	arme nucleare
SK	jadrová zbraň
SL	jedrsko orožje
FI	ydinase
SV	kärnvapen
HR	nuklearno oružje
SR	нуклеарно оружје



Summary

- To sum it up :
 - For a transparent and easy access to information, juridical information even more, one needs quality metadata;
 - Quality means both:
 - accuracy (for the value of the metadata), hence the importance of bibliographic and juridical indexation
 - and consistent use of standards for its presentation, transmission, storage, etc. which requires adoption of these standards following to the utmost possible extent international standards (Metadata registry project, EuroVoc);
 - This allows for easy communication and reuse of documents, precise interpretation of the related metadata (descriptive information) thus avoiding conversions, misunderstanding, loss of time, money and information; it allows as well new applications for the semantic web because of the ontologies modelling or for knowledge management;
 - Last but not least the standardisation of metadata make it possible to easily access contents coming from many sources from one access point or, as they are called, portal.





For further information or more detailed presentations, please contact:
yves.steinitz@publications.europa.eu

THANK YOU very much for your attention

